



# User Manual

## Elo TouchSystems 1940L Touchmonitor

**Copyright © 2012 Tyco Electronics Corporation, TE Connectivity Ltd. Company.  
All Rights Reserved.**

No part of this publication may be reproduced, transmitted, transcribed, stored in a retrieval system, or translated into any language or computer language, in any form or by any means, including, but not limited to, electronic, magnetic, optical, chemical, manual, or otherwise without prior written permission of Tyco Electronics.

**Disclaimer**

The information in this document is subject to change without notice. Tyco Electronics Corporation and its Affiliates in the TE Touch Solutions business unit in the TE Connectivity Ltd. family of companies (collectively "TE") makes no representations or warranties with respect to the contents herein, and specifically disclaims any implied warranties of merchantability or fitness for a particular purpose. TE reserves the right to revise this publication and to make changes from time to time in the content hereof without obligation of TE to notify any person of such revisions or changes.

**Trademark Acknowledgments**

AccuTouch, Elo (logo), Elo TouchSystems, IntelliTouch, TE Connectivity and TE (logo) are trademarks of the TE Connectivity Ltd. family of companies. Windows is a trademark of the Microsoft group of companies. Other product names mentioned herein may be trademarks or registered trademarks of their respective companies. Tyco Electronics claims no interest in trademarks other than its own.



# Table of Contents

<b>Chapter 1 - Introduction .....</b>	<b>4</b>
<b>Chapter 2 – Installation .....</b>	<b>5</b>
<b>Chapter 3 – Mounting .....</b>	<b>11</b>
<b>Chapter 4 – Operation .....</b>	<b>14</b>
<b>Chapter 5 – Technical Support.....</b>	<b>20</b>
<b>Chapter 6 – Safety &amp; Maintenance.....</b>	<b>21</b>
<b>Chapter 7 – Regulatory Information .....</b>	<b>22</b>
<b>Chapter 8 – Warranty Information.....</b>	<b>25</b>

# Chapter 1 - Introduction

## Product Description

---

Your new touchmonitor combines Elo TouchSystems reliable product performance with the latest developments in touch technology and display design. This combination of features creates a natural flow of information between a user and the touchmonitor.

This widescreen touchmonitor incorporates a 24-bit color, active matrix thin-film-transistor LCD panel to provide high quality display performance. Its HD resolution of 1366x768 is suitable for displaying graphics and images. Its LED backlight significantly reduces power consumption and eliminates mercury (compared to CCFL-backlit panels). Other features that enhance this LCD monitor's performance are Plug & Play compatibility and on-screen display (OSD) controls.

## Precautions

---

Follow all warnings, precautions and maintenance as recommended in this user manual to maximize the life of your unit and prevent risks to user safety. See the Safety & Maintenance chapter for more information.

This manual contains information that is important for the proper setup and maintenance of the unit. Before setting up and powering on your new touchmonitor, read through this manual, especially the Installation, Mounting, and Operation chapters.

# Chapter 2 –Installation

## Unpacking the Touchmonitor

---

Open the carton and verify the following items are present:

- Touchmonitor with protective sheet for its face
- Elo TouchTools CD & User Manuals CD
- Quick Install Guide
- Japanese language regulatory information pamphlet
- DVI cable (depending on model purchased)
- VGA cable
- USB cable
- REMOTE OSD controller

## Connector Panel & Interfaces

---

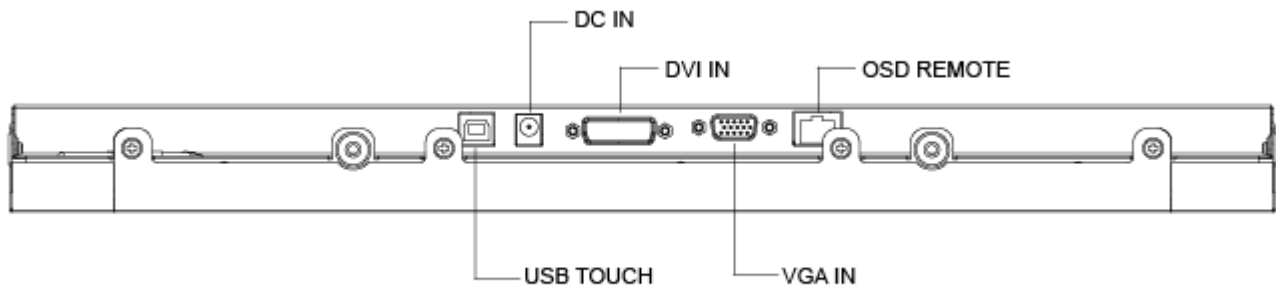

## Touchmonitor Connections

---

1. Connect the DVI or VGA video cables between the monitor's DVI/VGA input connectors and your DVI/VGA video source respectively. Tighten the video cable's screws with the best performance.
2. Connect the USB touch cable between the monitor's USB connector & your PC's USB port.
3. Connect a 12VDC power supply to the monitor's input power jack.
4. The touchmonitor ships in an ON state, video should be displayed on your monitor already.

# Installing the Touch Technology Software Drivers

Some software installation is required for your touchmonitor to work with your computer.

The drivers for the Windows 7, XP, Vista, WePOS, and 32-bit Server 2003 and 2008 operating systems are provided with your touchmonitor on a CD.

Visit the Elo TouchSystems website [www.elotouch.com](http://www.elotouch.com) for:

- The most up-to-date touch driver versions
- Additional touch driver information
- Detailed touch driver installation guides
- Touch drivers for other operating systems

Insert the Elo TouchTools CD into your computer's CD-ROM drive. The CD should automatically run the Elo TouchTools application. Select "Install Driver for This computer":



For Windows XP, Vista, Server 2003, Server 2008, and WEPOS installations, install the “USB Touchscreen Drivers” when prompted:

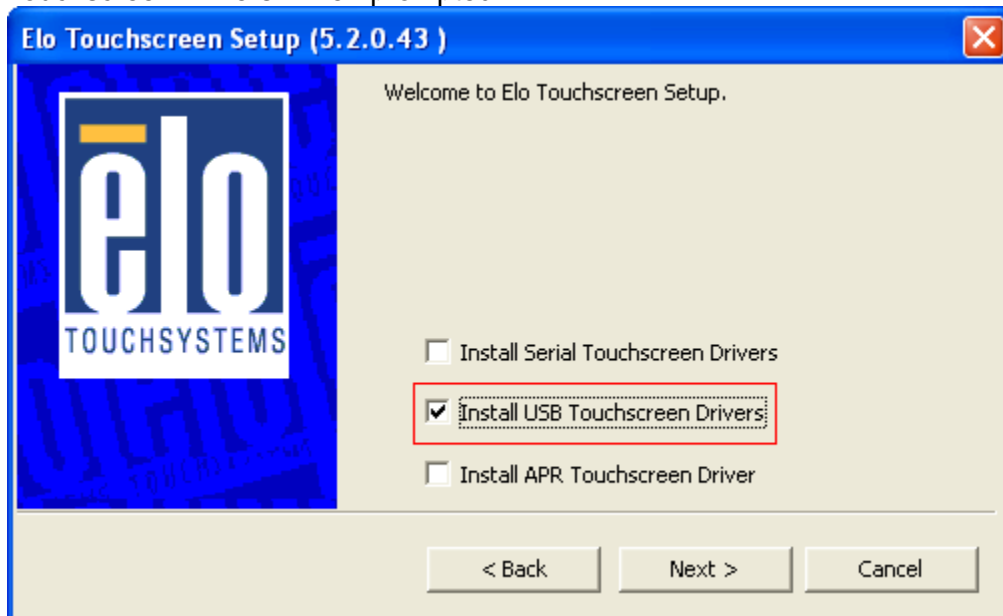

For Windows 7 installations, check the “Install driver” box under “Elo USB Interfaces – Other Touchscreens”

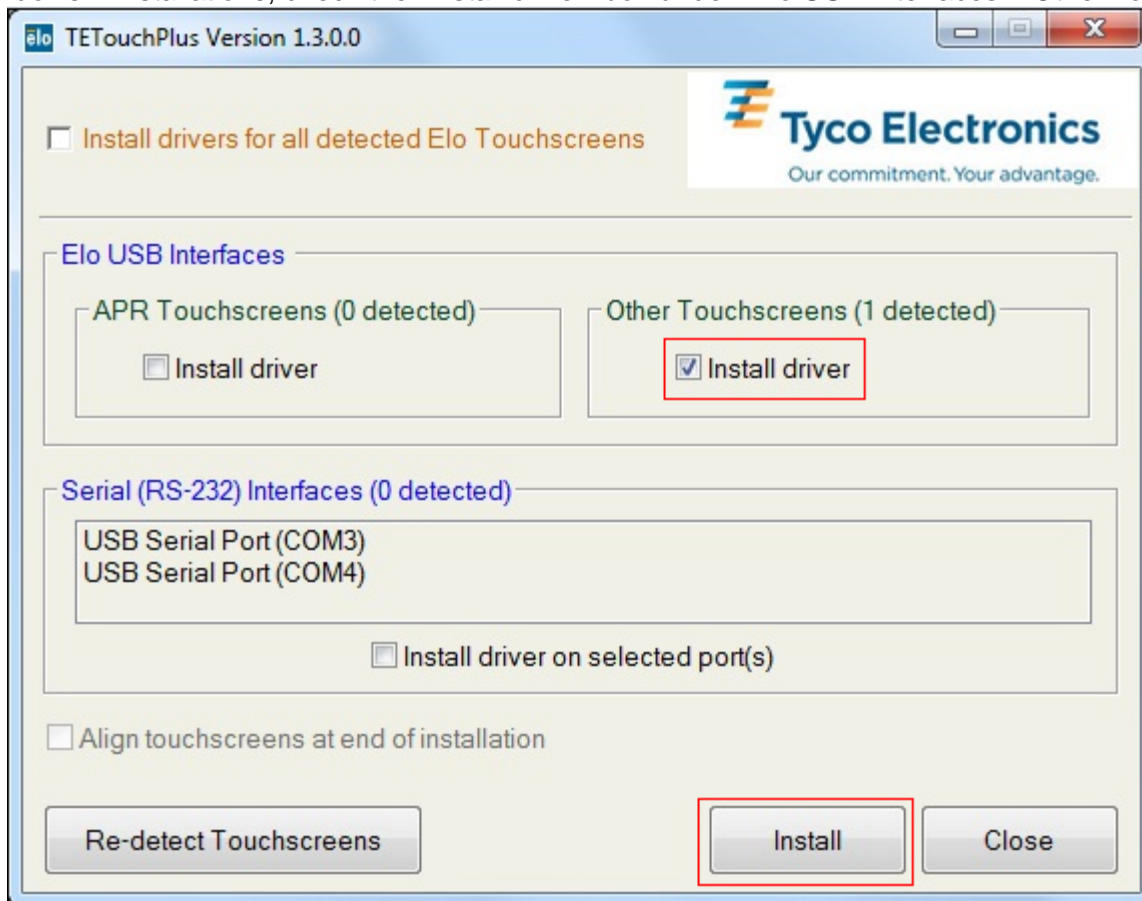

After accepting the end-user license agreement, the drivers will finish installing. Reboot your computer after the install is complete.

# Installing the Touch Driver-IntelliTouch Plus Touchscreen Technology

\*Multi-touch Support

\*USB

\*Single monitor

\*Windows 7 ONLY

Follow the directions on the screen to complete the driver setup for your Windows 7 system.

1. Insert the Elo CD-ROM in your computer's CD-ROM drive.
2. EloSetup launches.
3. Click "Install Driver for This Computer."
4. Click "Install drivers for all other Elo USB interfaces."
5. Click the "Install" button.

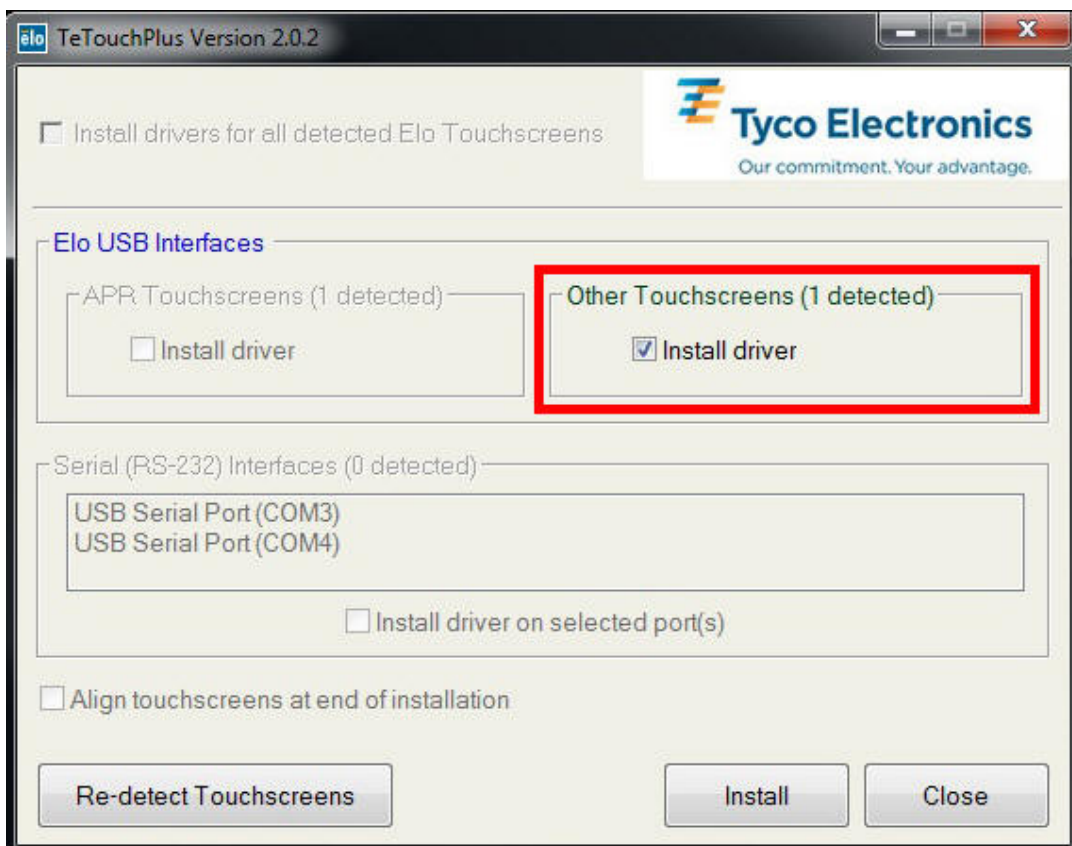



6. Review and accept the license agreement.

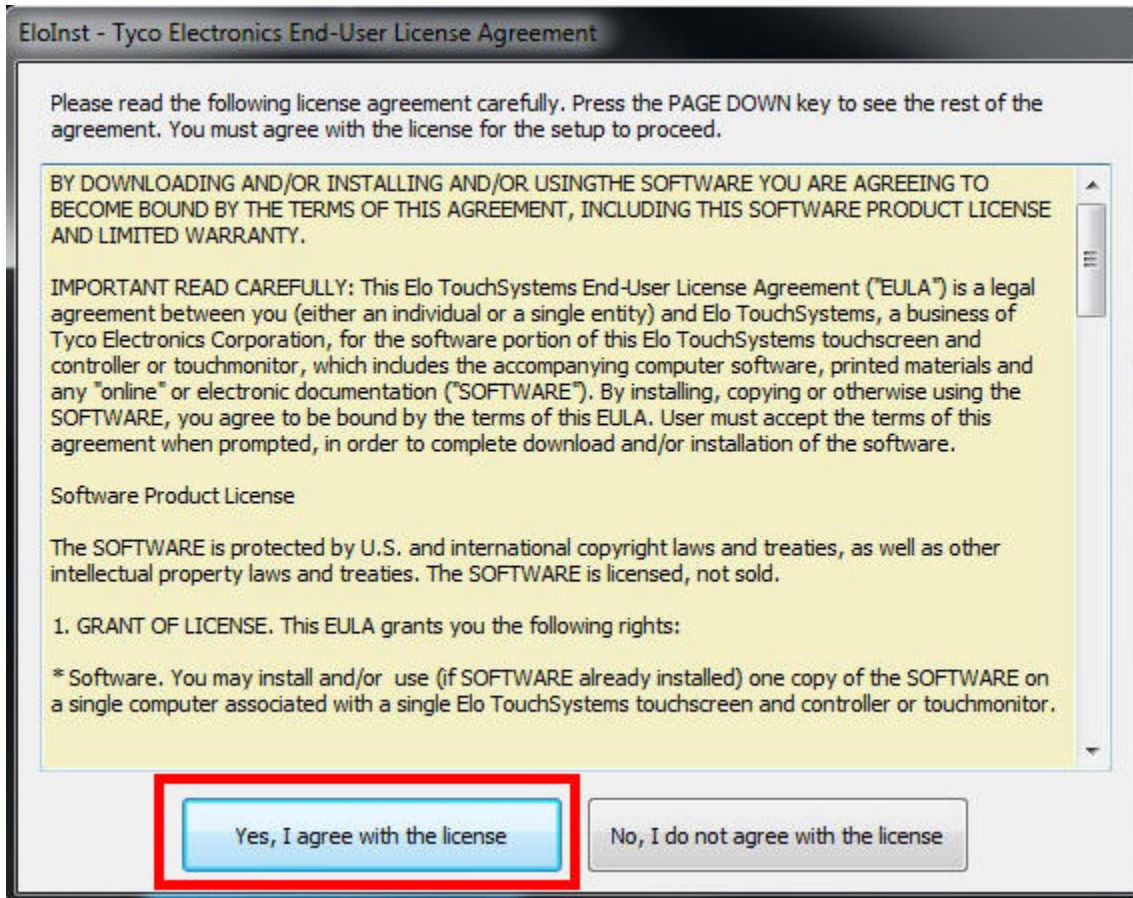

7. The touch driver setup is complete.

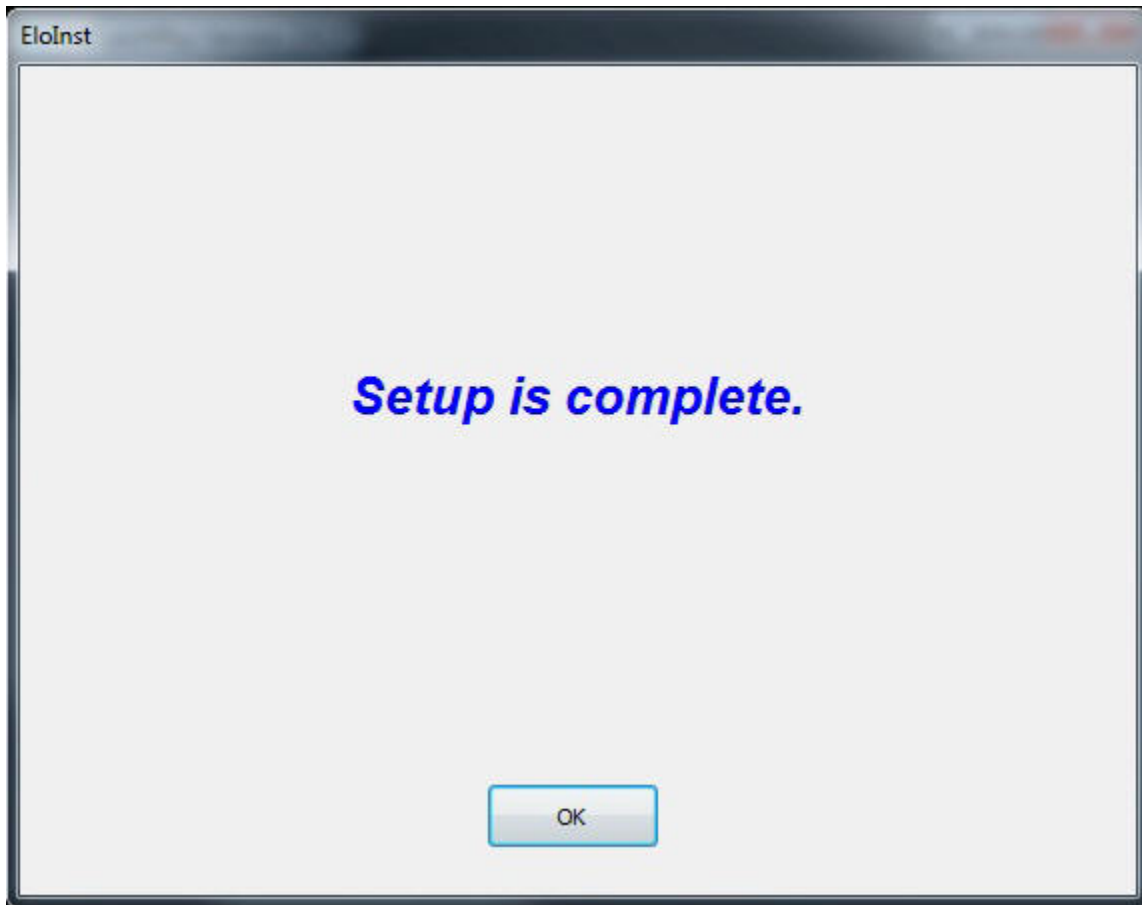

# Chapter 3 – Mounting

## General Mounting Information

The OSD text can be rotated through the OSD menu to better suit your mounting orientation.

## Rear VESA Mount

A four-hole 75x75mm mounting pattern for M4 screws is provided on the rear of the monitor. The VESA FDMI-compliant counting is coded: VESA MIS-D, 75, C.

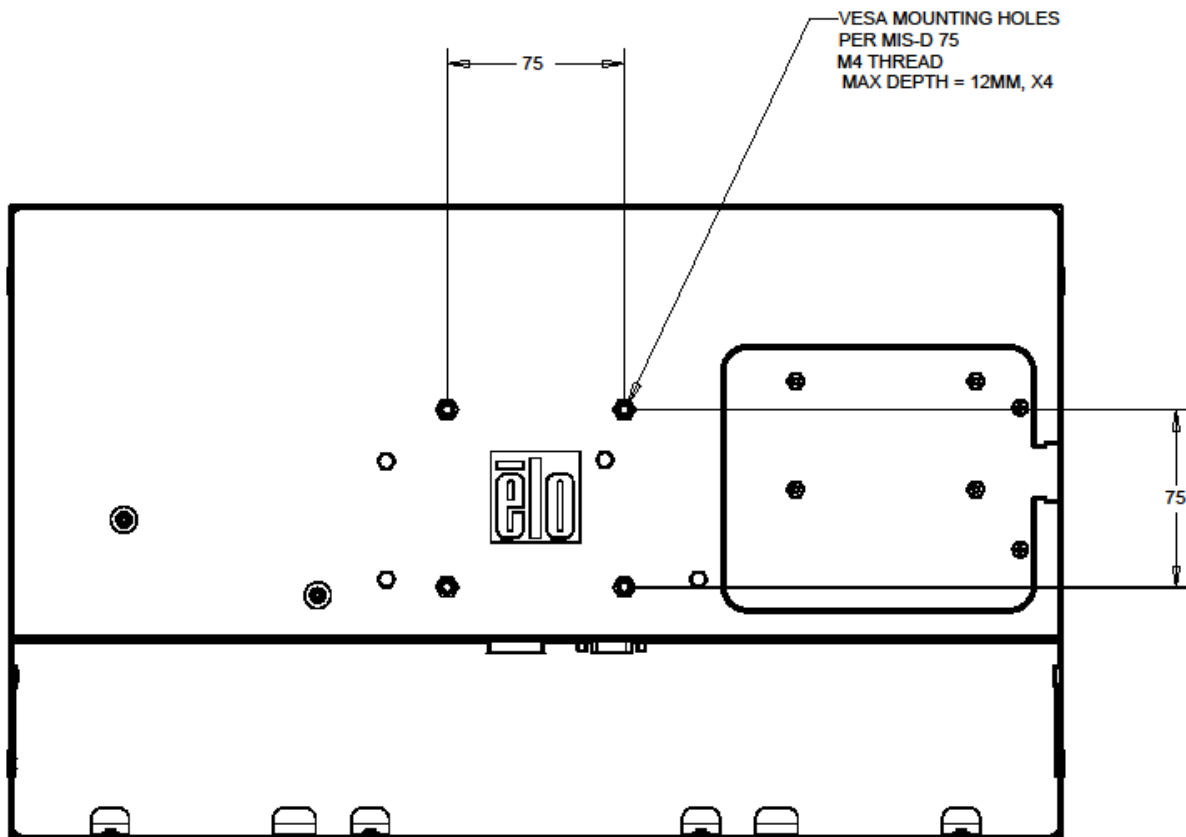

445.67

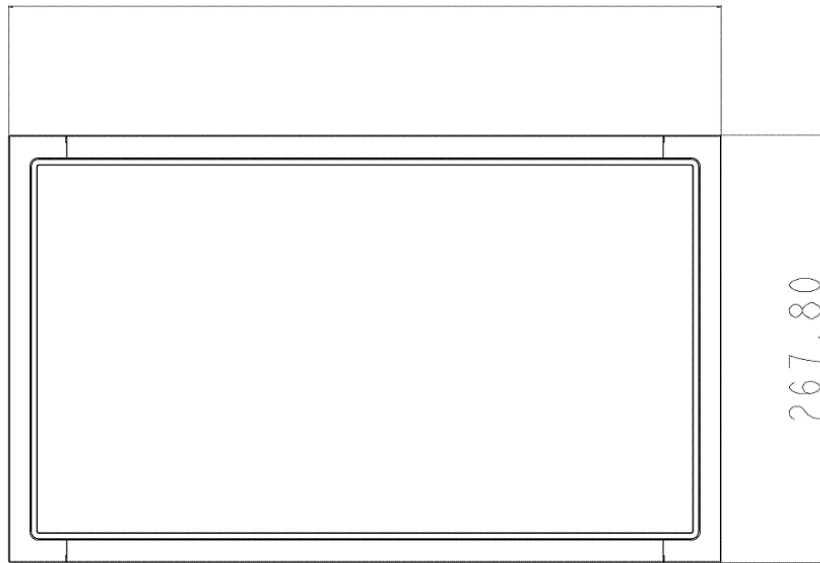

SCALE 1:100

# Side Bracket Mount

Threaded holes are provided on the sides of the monitor for mounting using the provided brackets.

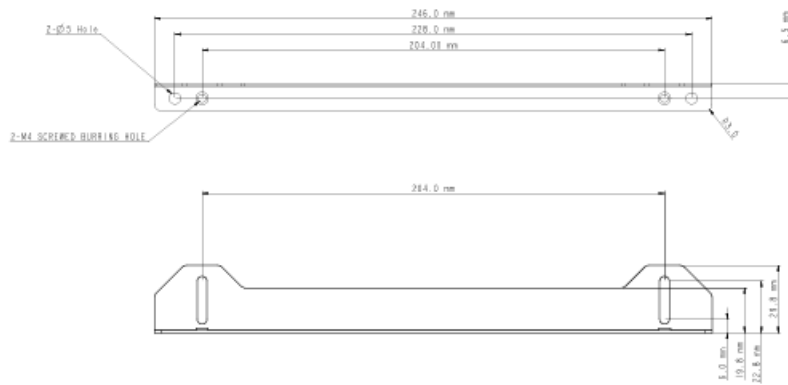
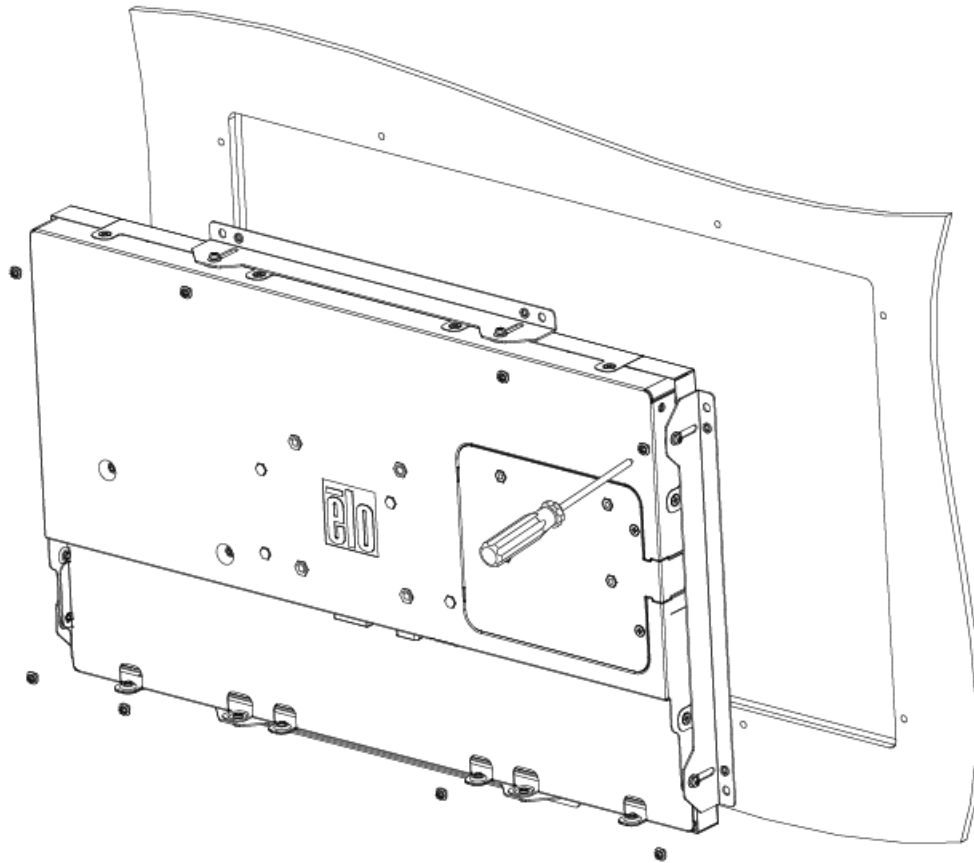

# Chapter 4 – Operation

## Power

---

To turn the touchmonitor on or off, press the touchmonitor power button once.

The Power Status LED on the REMOTE OSD controller functions according to the following table:

TouchMonitor/Computer Module status	LED status
OFF	OFF
SLEEP	PULSING
ON	ON

The system consumes low power when in SLEEP and OFF modes. For detailed power consumption specifications, refer to technical specifications on the Elo website <http://www.elotouch.com>

Touching the screen will bring the attached host PC out of SLEEP mode (similar to moving the mouse or pressing a keyboard key).

To improve reliability and reduce wasteful power consumption, disconnect the AC power cable from the power adapter when long periods of disuse are planned.

## Touch

---

Your IntelliTouch touchmonitor is factory-calibrated and should not need manual calibration (unless the input video is not fully scaled to the native resolution, or the touch experience needs to be calibrated to a specific user).

## IntelliTouch Plus Touchscreen Technology

---

When connected to Windows 7 computers, the touchmonitor can report 2 simultaneous touches.

When connected to Windows XP computers, the touchmonitor reports single touches.

The IntelliTouch Plus touchscreen can be re-calibrated to your displayed video image, if needed, through the Calibration function in the Elo driver control panel.

The IntelliTouch Plus driver will only support multiple monitor if they are all using the IntelliTouch Plus touch technology.

To use multiple IntelliTouch Plus monitors, double click on the EloConfig desktop shortcut to open up the Elo Touchscreen Configuration screen.



Select “Match Touch to Display...” to calibrate multiple monitors.



## Projected-Capacitive Touch Technology

When connected to Windows 7 computers, the touchmonitor can report 2 simultaneous touches.

When connected to Windows XP computers, the touchmonitor reports single touches.

No additional drivers are required for this touch technology to work, it uses Windows HID drivers.

No calibration is required for this touch technology.

## Gesture Support

The IntelliTouch Plus and projected capacitive touchscreen technologies enable several gestures that support single and multiple contacts. Refer to the Microsoft Website <http://msdn.microsoft.com/en-us/library/dd940543> on the various gestures that are supported in Windows 7.

## Video

---

A display's native resolution is its width and height measured in number of pixels. Generally, for best performance, an image displayed on this monitor will look best when your computer's output resolution matches this monitor's native resolution of 1366x768.

For computer output resolutions at non-native resolutions, the monitor will scale the video to its panel's native resolution. This involves stretching or compressing the input image as needed in the X- and Y-dimensions to fit the display's native resolution. An unavoidable byproduct of the scaling algorithms is a loss of fidelity when the computer's output video image is scaled by the monitor to fit the display. This loss of fidelity is most apparent when viewing feature-rich images at close distances (for example images containing small-font text).

Your touchmonitor will likely not require video adjustments. However, for analog VGA video, variations in video graphic card outputs may require user adjustments through the OSD to optimize the quality of the touchmonitor's displayed image. These adjustments are "remembered" by the touchmonitor. Also, to reduce the need for adjustments for different video mode timings, the monitor correctly scales and displays some of the video industry's most common video timing modes. Refer to the technical specifications for this monitor at <http://www.elotouch.com> for a list of these Preset Video Modes.



# On-Screen Display (OSD)

Five OSD buttons are located on REMOTE OSD controller. These can be used to adjust various display parameters.

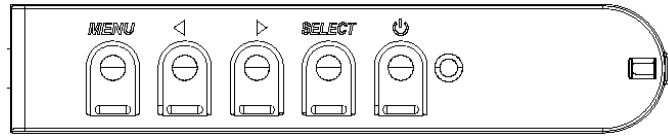

The buttons and their functionality are:

Button	Function when OSD is not displayed:	Function when OSD is displayed:
Menu	Display OSD main menu	Return to previous OSD menu
▶	Display OSD Brightness submenu	Increase value of selected parameter / select previous menu item
◀	Display OSD Contrast submenu	Decrease value of selected parameter / select next menu item
Select	Display Video Source submenu	Select parameter for adjustment / select submenu to enter
Power	Power on/off	Power on/off

Using the OSD buttons controls an on-screen graphical user interface which displays on top of your input video, allowing intuitive adjustment of the following display parameters:

Parameter	Available Adjustment
<b>Brightness</b>	Increase/decrease monitor brightness. Default: maximum
<b>Contrast</b>	Increase/decrease monitor contrast. Default: best gray-shade performance
<b>Clock</b>	Allows fine adjustments of the panel's pixel dot clock. <i>Only applicable for VGA input video</i>
<b>Phase</b>	Allows fine adjustments of the panel's pixel dot clock phase. <i>Only applicable for VGA input video</i>
<b>H-position</b>	Moves the image horizontally on the display in single-pixel increments. Default: centered. <i>Only applicable for VGA input video</i>
<b>V-position</b>	Moves the image vertically on the display in single-pixel increments. Default: centered. <i>Only applicable for VGA input video</i>
<b>Auto Adjust</b>	Automatically adjusts the system clock to the input analog VGA video signal, affecting the H-position, V-position, Clock, and Phase menu items. <i>Only applicable for VGA input video</i>

<b>Aspect Ratio</b>	<p>Switches the scaling method between Full Scaling and Maintain Aspect Ratio. Default: Full Scaling</p> <p>Full Scaling – scales the X- and Y-dimensions of the input video (up or down as needed) to the display’s native resolution. Fill To Aspect Ratio – Assuming a landscape orientation and an input video with aspect ratio smaller than 1920x1080, scales the Y-dimension of the input video (up or down as needed) to the display’s Y-resolution, and scales the X-dimension to maintain the input video’s aspect ratio (and fills the rest of the display with equal black bars on the left and right).</p>
<b>Sharpness</b>	<p>Adjusts sharpness of the displayed images. Default: no sharpness adjustment <i>Only applicable at non-native input video resolutions</i></p>
<b>Color Temperature</b>	<p>Selects the display’s color temperature. The available color temperatures are 9300K, 7500K, 6500K, 5500K, and User Defined. If the User Defined option is selected, the user can change the color temperature by changing individual R, G, and B gains on a scale from 0 to 100. Default: User Defined with R, G, and B all set to 100.</p>
<b>OSD Timeout</b>	<p>Adjusts how long a period of OSD button inactivity the touchmonitor will wait before closing the OSD. The adjustable range is between 5 and 60 seconds. Default: 15 seconds</p>
<b>OSD Rotation</b>	<p>Adjusts the OSD menu to “Portrait” or “Landscape” mode by 90 degrees clockwise.</p>
<b>OSD Language</b>	<p>Selects which language the OSD information is displayed in. The available languages are: English, French, Italian, German, Spanish, Simplified Chinese, Traditional Chinese, and Japanese. Default: English.</p>
<b>OSD H-Position</b>	<p>Adjusts the horizontal location of the OSD menus on the display Default: centered.</p>
<b>OSD V-Position</b>	<p>Adjusts the vertical location of the OSD menus on the display. Default: centered.</p>
<b>OSD Rotation</b>	<p>Selects which orientation the OSD text is displayed in. The available options are: 0 degrees (landscape) and 90 degrees (portrait). Default: 0 degrees (landscape)</p>
<b>Information</b>	<p>Displays the following information: 1940L TouchMonitor</p> <p>Monitor part number Monitor serial number</p> <p>Current video input source Current video resolution, V-sync frequency www.elotouch.com www.te.com</p>
<b>Recall Defaults</b>	<p>Selecting “Recall Defaults” restores all factory default settings for OSD-adjustable parameters (except OSD Language) and for Preset Video Mode timings.</p>
<b>Video Source</b>	<p>The monitor continually scans for active video on the VGA and DVI connectors. This adjustment selects which of those input ports should be given priority to be displayed. The options are: VGA Priority, DVI Priority Default: DVI Priority <i>Not available on models with only VGA input.</i></p>

All touchmonitor adjustments made through the OSD are automatically memorized as soon as they are entered. This feature saves you from having to reset your choices every time the touchmonitor is unplugged or powered off and on. If there is a power failure, the touchmonitor settings will not default to the factory specifications.

## OSD and Power Lockouts

---

Press and hold the “Menu” and “Up” buttons for two seconds to enable/disable the OSD Locking feature. When the OSD Locking is enabled, pressing any of the Menu, Up, Down, or Select keys will have no effect on the system.

Press and hold the “Menu” and “Down” buttons for two seconds to enable/disable the Power Locking feature. When the Power Locking is enabled, pressing the power switch will have no effect on the system.

# Chapter 5 – Technical Support

If you are experiencing trouble with your touchmonitor, refer to the following suggestions.  
If the problem persists, please contact your local dealer or contact Elo TouchSystems Customer Service.

## Solutions to Common Problems

---

Problem	Suggested Troubleshooting
The touchmonitor does not respond when turning on the system.	Check that the power cables are correctly attached. Verify the power supplies are functioning.
Monitor display is dim	Use the OSD to increase the brightness. Use the OSD to increase the contrast.
Monitor display is blank.	If the Power Status LED is blinking, the monitor or Computer Module may be in SLEEP mode. Press any key / move the mouse / touch the Touchscreen to see if the image reappears.
Monitor displays an “Out Of Range” message	Adjust your computer’s resolution/timing mode to be within the allowable timing ranges specified for your touchmonitor (see website for specifications)
Touch functionality doesn’t work	Verify your PC has the latest Elo drivers installed. Perform the calibration routine provided with the latest Elo drivers.

## Technical Assistance

---

Visit [www.elotouch.com/products](http://www.elotouch.com/products) for technical specifications for this device  
Visit [www.elotouch.com/go/websupport](http://www.elotouch.com/go/websupport) for online self-help.  
Visit [www.elotouch.com/go/contactsupport](http://www.elotouch.com/go/contactsupport) for technical support.  
See this user manual’s last page for worldwide technical support phone numbers.

# Chapter 6 - Safety & Maintenance

## Safety

To avoid risk of electric shock, follow all safety notices and do not disassemble the touchmonitor. They are not user-serviceable.

The slots located on the sides and top of the touchmonitor case are for ventilation. Do not block or insert anything inside the ventilation slots.

Ensure that your installation is equipped to maintain the specified environmental conditions listed in the Technical Specifications chapter.

## Care and Handling

The following tips will help keep your touchmonitor functioning at an optimal level:

- Disconnect the AC power cable before cleaning.
- To clean the display unit cabinet, use a clean cloth lightly dampened with a mild detergent.
- It is important that your unit remains dry. Do not get liquids on or inside the unit. If liquid does get inside, have a qualified service technician check it before you power it on again.
- Do not wipe the screen with a cloth or sponge that could scratch the surface.
- To clean the Touchscreen, use window or glass cleaner applied to a clean cloth or sponge. Never apply the cleaner directly to the touchscreen. Do not use alcohol (methyl, ethyl or isopropyl), thinner, benzene, or other abrasive cleaners.



## Waste Electrical & Electronic Equipment Directive (WEEE)



This product should not be disposed of with household waste. It should be deposited at a facility that enables recovery and recycling.

# Chapter 7 – Regulatory Information

## I. Electrical Safety Information:

Compliance is required with respect to the voltage, frequency, and current requirements indicated on the manufacturer's label. Connection to a different power source than those specified herein will likely result in improper operation, damage to the equipment or pose a fire hazard if the limitations are not followed.

There are no operator serviceable parts inside this equipment. There are hazardous voltages generated by this equipment which constitute a safety hazard. Service should be provided only by a qualified service technician.

Contact a qualified electrician or the manufacturer if there are questions about the installation prior to connecting the equipment to mains power.

## II. Emissions and Immunity Information

**Notice to Users in the United States:** This equipment has been tested and found to comply with the limits for a Class B digital device, pursuant to Part 15 of FCC Rules. These limits are designed to provide reasonable protection against harmful interference in a residential installation. This equipment generates, uses, and can radiate radio frequency energy, and if not installed and used in accordance with the instructions, may cause harmful interference to radio communications.

**Notice to Users in Canada:** This equipment complies with the Class B limits for radio noise emissions from digital apparatus as established by the Radio Interference Regulations of Industrial Canada.

**Notice to Users in the European Union:** Use only the provided power cords and interconnecting cabling provided with the equipment. Substitution of provided cords and cabling may compromise electrical safety or CE Mark Certification for emissions or immunity as required by the following standards:

This Information Technology Equipment (ITE) is required to have a CE Mark on the Manufacturer's label which means that the equipment has been tested to the following Directives and Standards: This equipment has been tested to the requirements for the CE Mark as required by EMC Directive 2004/108/EC as indicated in European Standard EN 55022 Class B and the Low Voltage Directive 2006/95/EC as indicated in European Standard EN 60950.

**General Information to all Users:** This equipment generates, uses and can radiate radio frequency energy. If not installed and used according to this manual the equipment may cause interference with radio and television communications. There is, however, no guarantee that interference will not occur in any particular installation due to site-specific factors.

1) In order to meet emission and immunity requirements, the user must observe the following:

a) Use only the provided I/O cables to connect this digital device with any computer.

b) To ensure compliance, use only the provided manufacturer's approved line cord.

c) The user is cautioned that changes or modifications to the equipment not expressly approved by the party responsible for compliance could void the user's authority to operate the equipment.

2) If this equipment appears to cause interference with radio or television reception, or any other device:

a) Verify as an emission source by turning the equipment off and on.

If you determine that this equipment is causing the interference, try to correct the interference by using one or more of the following measures:

i) Move the digital device away from the affected receiver.

ii) Reposition (turn) the digital device with respect to the affected receiver.

- iii) Reorient the affected receiver's antenna.
  - iv) Plug the digital device into a different AC outlet so the digital device and the receiver are on different branch circuits.
  - v) Disconnect and remove any I/O cables that the digital device does not use. (Unterminated I/O cables are a potential source of high RF emission levels.)
  - vi) Plug the digital device into only a grounded outlet receptacle. Do not use AC adapter plugs. (Removing or cutting the line cord ground may increase RF emission levels and may also present a lethal shock hazard to the user.)
- If you need additional help, consult your dealer, manufacturer, or an experienced radio or television technician.

### III. Agency Certifications

The following certifications and marks have been issued or declared for this monitor:

- Australia C-Tick
- Canada CUL, IC
- China CCC
- Europe CE
- Japan VCCI
- Korea KCC, e-Standby
- Mexico NOM CoC
- Taiwan BSMI
- United States FCC, UL

### IV. China RoHS

In accordance to Chinese law (Administration on the Control of Pollution Caused by Electronic Information Products), the section below lists out the name and amount of the toxic and/or hazardous materials that this product may contain.

Component Name	Toxic or Hazardous Substances and Elements					
	Lead(Pb)	Mercury(Hg)	Cadmium(Cd)	Hexavalent Chromium (Cr6+)	Polybrominated Biphenyls (PBB)	Polybrominated Diphenyl Ethers (PBDE)
Plastic Parts	O	O	O	O	O	O
Metal Parts	X	O	O	O	O	O
Wire and Cable Assembly	X	O	O	O	O	O
LCD Panel	X	O	O	O	O	O
Touch Screen Panel	X	O	O	O	O	O
PCBA	X	O	O	O	O	O
Software (CD, etc.)	O	O	O	O	O	O

O: Indicates that this toxic or hazardous substance contained in all of the homogeneous materials for this component is below the limit requirement in SJ/T11363-2006.

X: Indicates that this toxic or hazardous substance contained in at least one of the homogeneous materials used for this component is above the limit requirement in SJ/T11363-2006. For items marked with X, exemptions were taken according to EU RoHS.

#### Explanation of Markings

(1). In accordance with the SJ/T11364-2006 requirement, the electronic information products are marked with the following pollution control logo. The Environment-Friendly Use Period for this product is 10 years. The product will not leak or mutate under normal operating conditions listed below, so that the use of this electronic information product will not result in any severe environmental pollution, any bodily injury, or damage to any assets.

Operating Temperature:0-40 / Humidity:20%-80% (non-condensing).

Storage Temperature:-20~60 / Humidity:10%~90% (non-condensing).



(2). It is encouraged and recommended that this product be recycled and reused according to local laws. The product should not be thrown away casually.

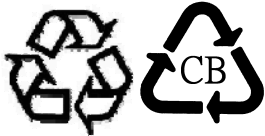

#### V. Power Adapter Specifications

Electrical Ratings:

Input: 100-240VAC, 50-60Hz

Output: 12VDC, minimum 4.16A, LPS

#### VI. Monitor Specifications

Electrical Ratings:

Input: 12VDC, 2.1 A

Operating Conditions:

Temperature: 0°C - 40°C

Humidity: 20% to 80% (non-condensing)

Altitude: 0 to 3,048m

Storage Conditions:

Temperature: -20°C - 60°C

Humidity: 10% to 90% (non-condensing)

Altitude: 0 to 12,192m



# Chapter 8 – Warranty Information

Except as otherwise stated herein, or in an order acknowledgment delivered to Buyer, Seller warrants to Buyer that the Product shall be free of defects in materials and workmanship. The warranty for the TouchMonitors, and their components is 3 (three) years.

Seller makes no warranty regarding the model life of components. Seller's suppliers may at any time and from time to time make changes in the components delivered as Products or components.

Buyer shall notify Seller in writing promptly (and in no case later than thirty days after discovery) of the failure of any Product to conform to the warranty set forth above; shall describe in commercially reasonable detail in such notice the symptoms associated with such failure; and shall provide to Seller the opportunity to inspect such Products as installed, if possible. The notice must be received by Seller during the Warranty Period for such product, unless otherwise directed in writing by the Seller. Within thirty days after submitting such notice, Buyer shall package the allegedly defective Product in its original shipping carton(s) or a functional equivalent and shall ship to Seller at Buyer's expense and risk.

Within a reasonable time after receipt of the allegedly defective Product and verification by Seller that the Product fails to meet the warranty set forth above, Seller shall correct such failure by, at Seller's options, either (i) modifying or repairing the Product or (ii) replacing the Product. Such modification, repair, or replacement and the return shipment of the Product with minimum insurance to Buyer shall be at Seller's expense. Buyer shall bear the risk of loss or damage in transit, and may insure the Product. Buyer shall reimburse Seller for transportation cost incurred for Product returned but not found by Seller to be defective. Modification or repair, of Products may, at Seller's option, take place either at Seller's facilities or at Buyer's premises. If Seller is unable to modify, repair, or replace a Product to conform to the warranty set forth above, then Seller shall, at Seller's option, either refund to Buyer or credit to Buyer's account the purchase price of the Product less depreciation calculated on a straight-line basis over Seller's stated Warranty Period.

These remedies shall be the buyer's exclusive remedies for breach of warranty. Except for the express warranty set forth above, seller grants no other warranties, express or implied by statute or otherwise, regarding the products, their fitness for any purpose, their quality, their merchantability, their non-infringement, or otherwise. No employee of Seller or any other party is authorized to make any warranty for the goods other than the warranty set forth herein. Seller's liability under the warranty shall be limited to a refund of the purchase price of the product. In no event shall Seller be liable for the cost of procurement or installation of substitute goods by Buyer or for any special, consequential, indirect, or incidental damages.

Buyer assumes the risk and agrees to indemnify Seller against and hold Seller harmless from all liability relating to (i) assessing the suitability for Buyer's intended use of the Products and of any system design or drawing and (ii) determining the compliance of Buyer's use of the Products with applicable laws, regulations, codes, and standards. Buyer retains and accepts full responsibility for all warranty and other claims relating to or arising from Buyer's products, which include or incorporate Products or components manufactured or supplied by Seller. Buyer is solely responsible for any and all representations and warranties regarding the Products made or authorized by Buyer. Buyer will indemnify Seller and hold Seller harmless from any liability, claims, loss, cost, or expenses (including reasonable attorney's fees) attributable to Buyer's products or representations or warranties concerning same.

**Check out the Elo TouchSystems Website!**

**[www.elotouch.com](http://www.elotouch.com)**

---

*Get the latest...*

- 
- *Product Information*
- 
- *Specifications*
- 
- *News on upcoming events*
- 
- *Press releases*
- 
- *Software drivers*
- 
- *TouchMonitor Newsletter*
- 

### **Getting in Touch with us**

To find out more about the extensive range of Elo touch solutions, visit our Website at [www.elotouch.com](http://www.elotouch.com), or simply call the office nearest you:

#### **North America**

TE Touch Solutions  
301 Constitution Drive  
Menlo Park, CA 94025  
USA

Tel 800-ELO-TOUCH  
Tel 800-557-1458  
Tel 650-361-4800  
Fax 650-361-4722  
[customerservice@elotouch.com](mailto:customerservice@elotouch.com)

#### **Belgium**

Tyco Electronics Raychem bvba  
Diestsesteenweg 692  
B-3010 Kessel-Lo  
Belgium

Tel +32(0)(16)35-2100  
Fax +32(0)(16)35-2101  
[elosales@elotouch.com](mailto:elosales@elotouch.com)

#### **Asian-Pacific**

Sun Homada Bldg. 2F  
1-19-20 Shin-Yokohama  
Kanagawa 222-0033  
Japan

Tel +81(45)478-2161  
Fax +81(45)478-2180  
[www.tps.co.jp](http://www.tps.co.jp)

#### **Latin America**

TE Touch Solutions  
20801 Biscayne Blvd, Ste. 403  
Miami, FL 33180  
USA

Tel 786-923-0251  
Fax 305-931-0124  
[carlos.valladares@te.com](mailto:carlos.valladares@te.com)

©2012 Tyco Electronics Corporation, a TE Connectivity Ltd. Company. All rights reserved.

